

YDS-W5MA-IMX258 V1.0

13MP Sony IMX258 MIPI-Schnittstelle Autofokus Kameramodul



Vorderansicht



Rückansicht

Spezifikationen

Kameramodul Nr.	YDS-W5MA-IMX258 V1.0
Auflösung	13MP
Bildsensor	IMX258
Sensorart	1/3.06"
Pixel Größe	1.12 um x 1.12 um
EFL	3.81 mm
F.NO	2.20
Pixel	4224 x 3136
Betrachtungswinkel	74.4°(DFOV) 62.7°(HFOV) 48.7°(VFOV)
Linsenabmessungen	8.50 x 8.50 x 5.60 mm
Modulgröße	47.50 x 8.50 mm
Modultyp	Autofokus
Schnittstelle	MIPI
Autofokus-VCM-Treiber-IC	DW9763
Linsenmodell	YDS-LENS-50013A1
Linsentyp	650 nm IR-Schnitt
Betriebstemperatur	-20°C to +70°C
Gegenstecker	AXT530124

YDS-W5MA-IMX258 V1.0

13MP Sony IMX258 MIPI-Schnittstelle Autofokus Kameramodul



Ansicht von oben



Seitenansicht



Untersicht

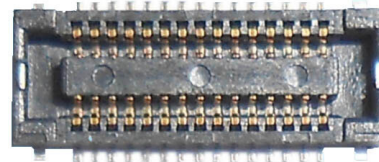

Gegenstecker

[Product Brief]

Ver.1.0

IMX258

Diagonal 5.867 mm (Type 1/3.06) 13Mega-Pixel CMOS Image Sensor with Square Pixel for Color Cameras

Description

IMX258 is a diagonal 5.867mm (Type 1/3.06) 13 Mega-pixel CMOS active pixel type stacked image sensor with a square pixel array. It adopts Exmor R^{STM} technology to achieve high speed image capturing by column parallel A/D converter circuits and high sensitivity and low noise image (comparing with conventional CMOS image sensor) through the backside illuminated imaging pixel structure. R, G, and B pigment primary color mosaic filter is employed. By introducing spatially multiplexed exposure technology, high dynamic range still pictures and movies are achievable. It

equips an electronic shutter with variable integration time. It operates with three power supply voltages: analog 2.7 V, digital 1.2 V and 1.8 V for input/output interface and achieves low power consumption.

In addition, this product is designed for use in cellular phone and tablet pc. When using this for another application, Sony does not guarantee the quality and reliability of product. Therefore, don't use this for applications other than cellular phone and tablet pc. Consult your Sony sales representative if you have any questions.

Functions and Features

- ◆ Back-illuminated and stacked CMOS image sensor Exmor R^{STM}
- ◆ Phase Detection pixel data output for Phase Detection Auto Focus
- ◆ High Dynamic Range (HDR) mode with raw data output.
- ◆ High signal to noise ratio (SNR).
- ◆ Full resolution @30fps (Normal / HDR). 4K2K @30fps (Normal / HDR) 1080p @60fps (Normal)
- ◆ Output video format of RAW10/8.
- ◆ Pixel binning readout and V sub-sampling function.
- ◆ Independent flipping and mirroring.
- ◆ CSI-2 serial data output (MIPI 2lane/4lane, Max. 1.3Gbps/lane, D-PHY spec. ver. 1.1 compliant)
- ◆ 2-wire serial communication.
- ◆ Two PLLs for independent clock generation for pixel control and data output interface.
- ◆ Dynamic Defect Pixel Correction.
- ◆ Fast mode transition. (on the fly)
- ◆ Dual sensor synchronization operation.
- ◆ 4K bit of OTP ROM for users.
- ◆ Built-in temperature sensor.

Device Structure

- ◆ CMOS image sensor
- ◆ Image size : Diagonal 5.867 mm (Type 1/3.06)
- ◆ Total number of pixels : 4224 (H) × 3192 (V) approx. 13.48 M pixels
- ◆ Number of effective pixels : 4224 (H) × 3144 (V) approx. 13.28 M pixels
- ◆ Number of active pixels : 4208 (H) × 3120 (V) approx. 13.13 M pixels
- ◆ Chip size : 5.990 mm (H) × 3.908 mm (V)
- ◆ Unit cell size : 1.12 μm (H) × 1.12 μm (V)
- ◆ Substrate material : Silicon

System block diagram

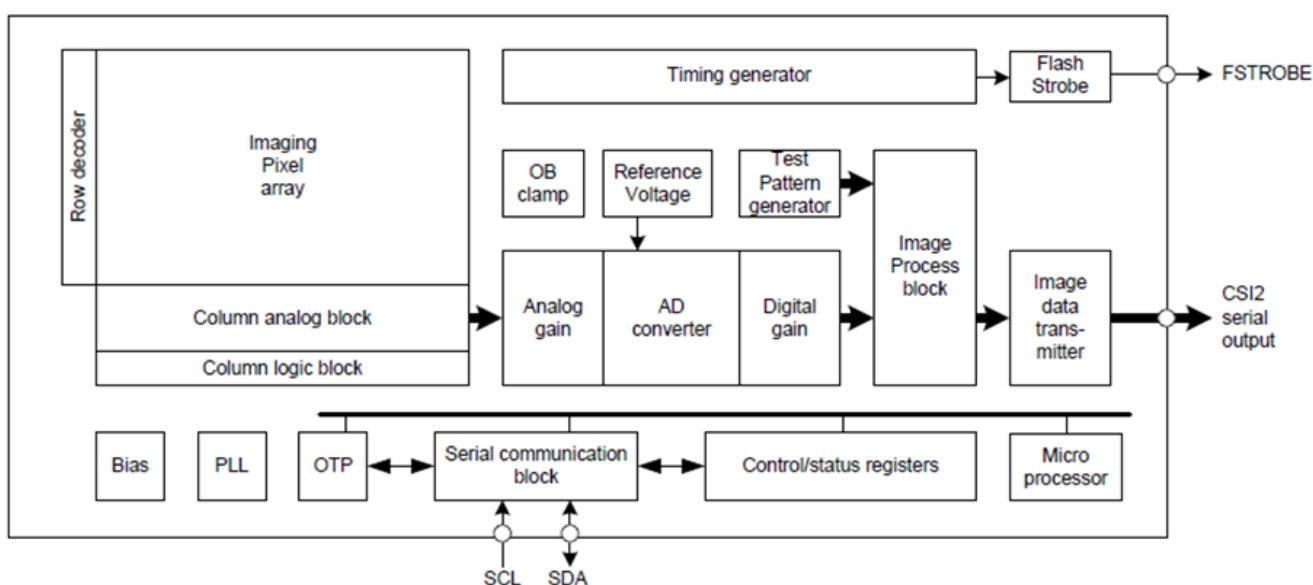

Exmor RS

* Exmor RS is a trademark of Sony Corporation. The Exmor RS is a Sony's CMOS image sensor with high-resolution, high-performance and compact size by replacing a supporting substrate in Exmor R™ which changed fundamental structure of Exmor™ pixel adopted column parallel A/D converter to back-illuminated type, with layered chips formed signal processing circuits.

1. General Description

The DW9763 is a single 10-bit DAC with 100mA output current sinking capability and embedded 8KByte eFlash memory. Designed for linear control of voice coil motors, the DW9763 is capable of operating voltage up to 3.3V.

The SAC (Smart Actuator Control) mode is applied to minimize the mechanical vibration. The SAC mode highly improves the actuator's settling time and tolerance coverage compared with conventional LSC (Linear Slope Control) mode. The DAC and eFlash are controlled via an I2C compatible serial interface.

The DW9763 incorporates with a POR (Power On Reset) circuit, power down mode. POR circuit gets to operate when VDD (supply power) turns on. The output current keeps 0mA until valid register value takes place. During the power down mode, it consumes current max.1uA.

The DW9763 is designed for auto focus and optical zoom for mobile camera, digital still camera, camcorders and other nano actuator applications.

■ Features

- 10 bit resolution current sinking of 100mA for VCM
- SAC (Smart Actuator Control) mode
- Supply voltage range (VDD) : 2.3V to 3.3V
- Fast mode I2C interface compatible (1.8V interface available)
- Power down mode
- Power on reset (POR)
- Embedded 8KByte eFlash memory
- Package : 8 pin WLCSP
- Package Size : 0.77mm X 1.75mm X 0.3mm

■ Applications

- Mobile camera
- Digital still camera
- Camcorder
- Web camera
- Nano actuator

YDS-LENS-50013A1

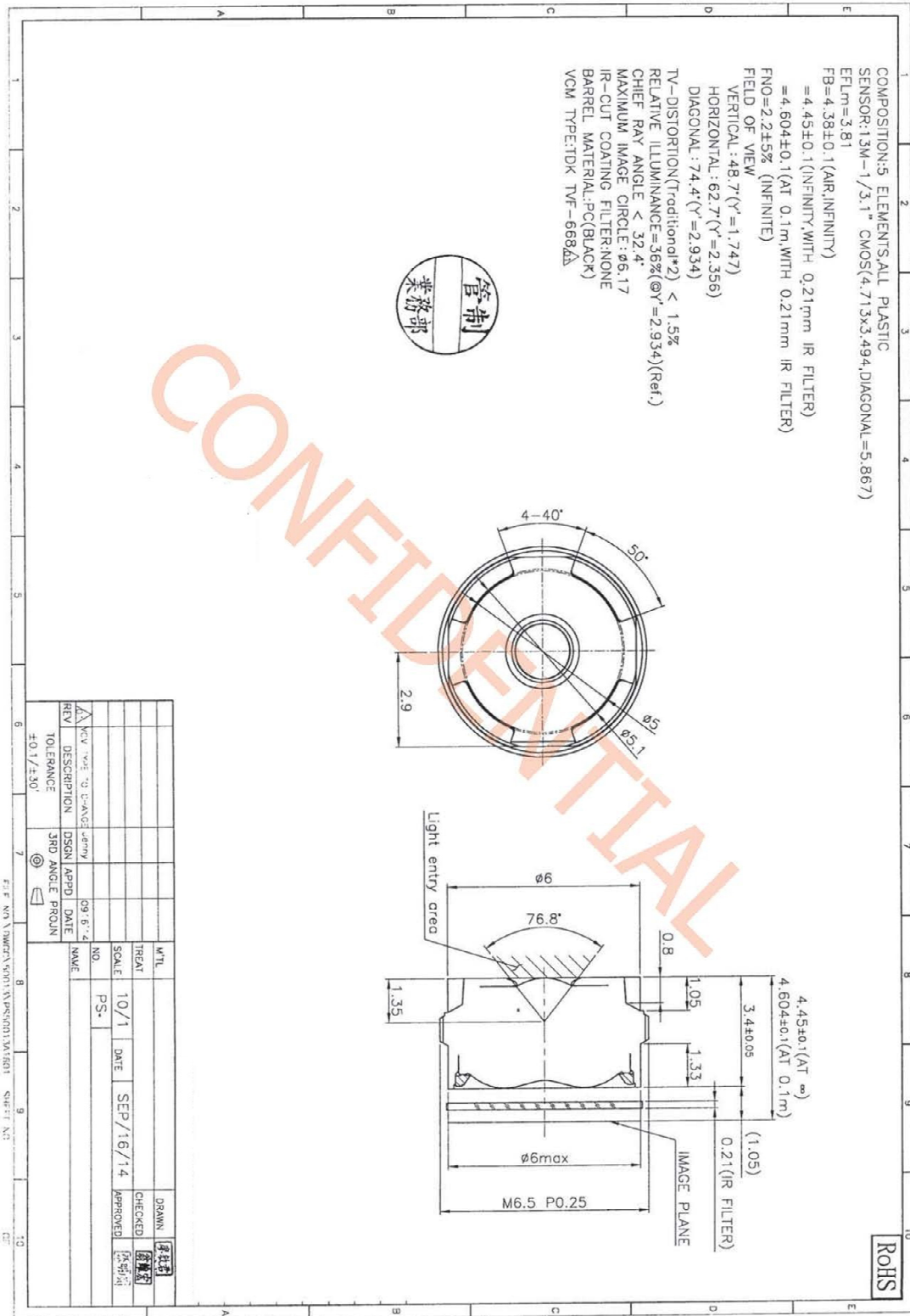

NARROW-PITCH, THIN AND SLIM CONNECTOR FOR BOARD-TO-FPC CONNECTION

NARROW PITCH (0.4 mm) CONNECTORS F4S SERIES

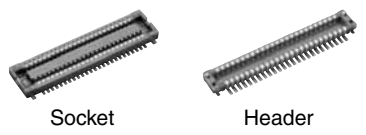

Compliance with RoHS Directive

FEATURES

1. Space-saving (3.6 mm widthwise)
 The required space is smaller than our F4 series (40-contact type):
 Socket — 27% smaller,
 Header — 38% smaller
 The small size contributes to the miniaturization of target equipment.

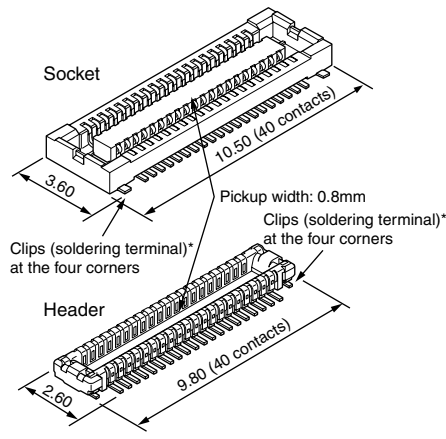

* Clips for preventing the solder joints from being removed

2. Highly reliable
TOUGH CONTACT has strong resistance to adverse environments.
 (See Page 6 for details of the structure)
 Note: If extra resistance to shock caused by dropping is required, we recommend using our previous F4 Series.

3. The simple lock structure gives tactile feedback that ensures a superior mating/unmating operation feel.

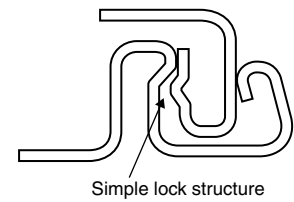

4. Gull-wing type terminals
 The gull-wing type terminals facilitate automatic mounting inspections.
5. Connectors for inspection available
 Connectors for inspection are available that are ideal for modular unit inspection and inspection in device assembly processes.

APPLICATIONS

Compact portable devices “Cellular phones, DVC, Digital cameras, etc”

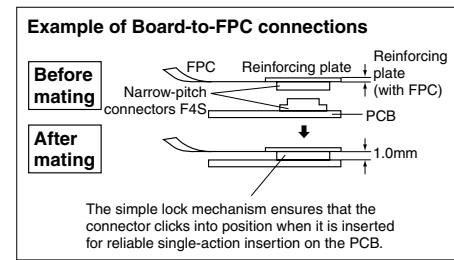

ORDERING INFORMATION

AXT **4**

5: Narrow Pitch Connector F4S (0.4 mm pitch) Socket
 6: Narrow Pitch Connector F4S (0.4 mm pitch) Header

Number of contacts (2 digits)

Mated height
 <Socket>
 1: For mated height 1.0 mm
 2: For mated height 1.2 mm
 <Header>
 1: For mated height 1.0 mm
 2: For mated height 1.2 mm

Functions
 <Socket, Header>
 2: Without positioning bosses

Surface treatment (Contact portion / Terminal portion)
 <Socket>
 4: Base: Ni plating Surface: Au plating (for Ni barrier available)
 <Header>
 4: Base: Ni plating Surface: Au plating

Note: Please note that models with a mated height of 1.0 mm (7th digit of part number is “1”) and 1.2 mm (7th digit of part number is “2”) are not compatible.

AXT5, 6

PRODUCT TYPES

Mated height	Number of contacts	Part number		Packing	
		Socket	Header	Inner carton	Outer carton
1.0mm	10	AXT510124	AXT610124	3,000 pieces	6,000 pieces
	12	AXT512124	AXT612124		
	14	AXT514124	AXT614124		
	16	AXT516124	AXT616124		
	18	AXT518124	AXT618124		
	20	AXT520124	AXT620124		
	22	AXT522124	AXT622124		
	24	AXT524124	AXT624124		
	26	AXT526124	AXT626124		
	28	AXT528124	AXT628124		
	30	AXT530124	AXT630124		
	32	AXT532124	AXT632124		
	34	AXT534124	AXT634124		
	36	AXT536124	AXT636124		
	38	AXT538124	AXT638124		
	40	AXT540124	AXT640124		
	42	AXT542124	AXT642124		
	44	AXT544124	AXT644124		
	46	AXT546124	AXT646124		
	48	AXT548124	AXT648124		
50	AXT550124	AXT650124			
54	AXT554124	AXT654124			
60	AXT560124	AXT660124			
64	AXT564124	AXT664124			
70	AXT570124	AXT670124			
80	AXT580124	AXT680124			
1.2mm	10	AXT510224	AXT610224		
	30	AXT530224	AXT630224		
	40	AXT540224	AXT640224		
	50	AXT550224	AXT650224		
	80	AXT580224	AXT680224		

- Notes: 1. Order unit: For mass production: in 1-inner-box (1-reel) units
 Samples for mounting check: in 50-connector units. Please contact our sales office.
 Samples: Small lot orders are possible. Please contact our sales office.
2. The above part numbers are for connectors without positioning bosses, which are standard. When ordering connectors with positioning bosses, please contact our sales office.
3. Please contact us for connectors having a number of contacts other than those listed above.

SPECIFICATIONS

1. Characteristics

	Item	Specifications	Conditions
Electrical characteristics	Rated current	0.3A/contact (Max. 5 A at total contacts)	
	Rated voltage	60V AC/DC	
	Breakdown voltage	150V AC for 1 min.	No short-circuiting or damage at a detection current of 1 mA when the specified voltage is applied for one minute.
	Insulation resistance	Min. 1,000M Ω (initial)	Using 250V DC megger (applied for 1 min.)
	Contact resistance	Max. 90m Ω	Based on the contact resistance measurement method specified by JIS C 5402.
Mechanical characteristics	Composite insertion force	Max. 0.981N/contacts \times contacts (initial)	
	Composite removal force	Min. 0.165N/contacts \times contacts	
Environmental characteristics	Contact holding force (Socket contact)	Min. 0.49N/contacts	Measuring the maximum force. As the contact is axially pull out.
	Ambient temperature	-55°C to +85°C	No freezing at low temperatures. No dew condensation.
	Soldering heat resistance	Peak temperature: 260°C or less (on the surface of the PC board around the connector terminals) 300°C within 5 sec. 350°C within 3 sec.	Infrared reflow soldering Soldering iron
	Storage temperature	-55°C to +85°C (product only) -40°C to +50°C (emboss packing)	No freezing at low temperatures. No dew condensation.
	Thermal shock resistance (header and socket mated)	5 cycles, insulation resistance min. 100M Ω , contact resistance max. 90m Ω	Sequence 1. -55 $\frac{3}{5}$ °C, 30 minutes 2. ~, Max. 5 minutes 3. 85 $\frac{3}{5}$ °C, 30 minutes 4. ~, Max. 5 minutes
	Humidity resistance (header and socket mated)	120 hours, insulation resistance min. 100M Ω , contact resistance max. 90m Ω	Bath temperature 40 \pm 2°C, humidity 90 to 95% R.H.
	Saltwater spray resistance (header and socket mated)	24 hours, insulation resistance min. 100M Ω , contact resistance max. 90m Ω	Bath temperature 35 \pm 2°C, saltwater concentration 5 \pm 1%
H ₂ S resistance (header and socket mated)	48 hours, contact resistance max. 90m Ω	Bath temperature 40 \pm 2°C, gas concentration 3 \pm 1 ppm, humidity 75 to 80% R.H.	
Lifetime characteristics	Insertion and removal life	50 times	Repeated insertion and removal speed of max. 200 times/hours
Unit weight		20-contact type: Socket: 0.03 g Header: 0.01 g	

2. Material and surface treatment

Part name	Material	Surface treatment
Molded portion	LCP resin (UL94V-0)	—
Contact and Post	Copper alloy	Contact portion: Base: Ni plating Surface: Au plating Terminal portion: Base: Ni plating Surface: Au plating (except the terminal tips) The socket terminals close to the portion to be soldered have nickel barriers (exposed nickel portions). Metal clips: Sockets: Base: Ni plating Surface: Pd+Au flash plating (except the terminal tips) Headers: Base: Ni plating Surface: Au plating (except the terminal tips)

AXT5, 6

DIMENSIONS (Unit: mm) The CAD data of the products with a **CAD Data** mark can be downloaded from: <http://panasonic-electric-works.net/ac>

Socket (Mated height: 1.0 mm and 1.2 mm)

CAD Data

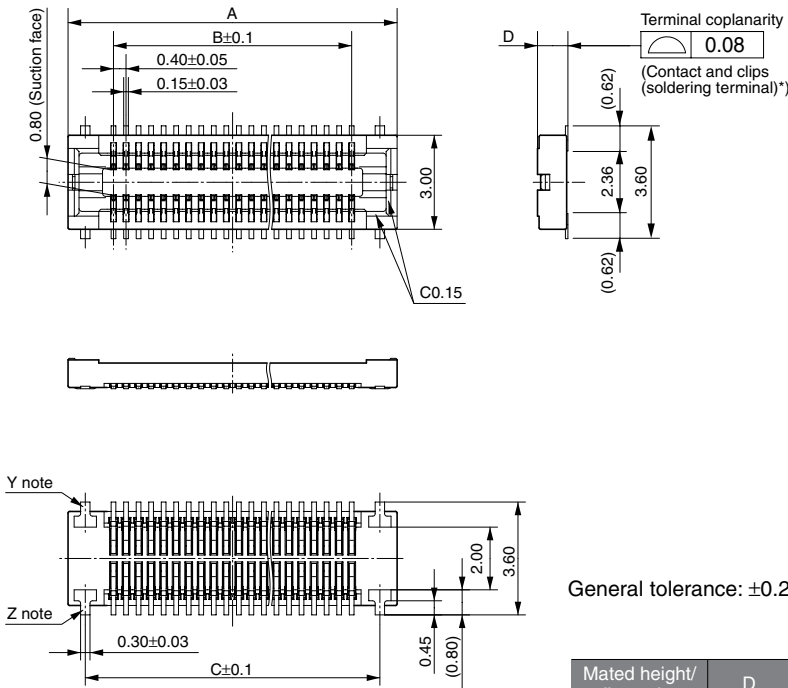

General tolerance: ±0.2

Mated height/ dimension	D
1.0mm	0.97
1.2mm	1.17

Note: Since the clip (soldering terminal)* has a single-piece construction, sections Y and Z are electrically connected.

Dimension table (mm)

Number of contacts/ dimension	A	B	C
10	4.5	1.6	3.4
12	4.9	2.0	3.8
14	5.3	2.4	4.2
16	5.7	2.8	4.6
18	6.1	3.2	5.0
20	6.5	3.6	5.4
22	6.9	4.0	5.8
24	7.3	4.4	6.2
26	7.7	4.8	6.6
28	8.1	5.2	7.0
30	8.5	5.6	7.4
32	8.9	6.0	7.8
34	9.3	6.4	8.2
36	9.7	6.8	8.6
38	10.1	7.2	9.0
40	10.5	7.6	9.4
42	10.9	8.0	9.8
44	11.3	8.4	10.2
46	11.7	8.8	10.6
48	12.1	9.2	11.0
50	12.5	9.6	11.4
54	13.3	10.4	12.2
60	14.5	11.6	13.4
64	15.3	12.4	14.2
70	16.5	13.6	15.4
80	18.5	15.6	17.4

Header (Mated height: 1.0 mm and 1.2 mm)

CAD Data

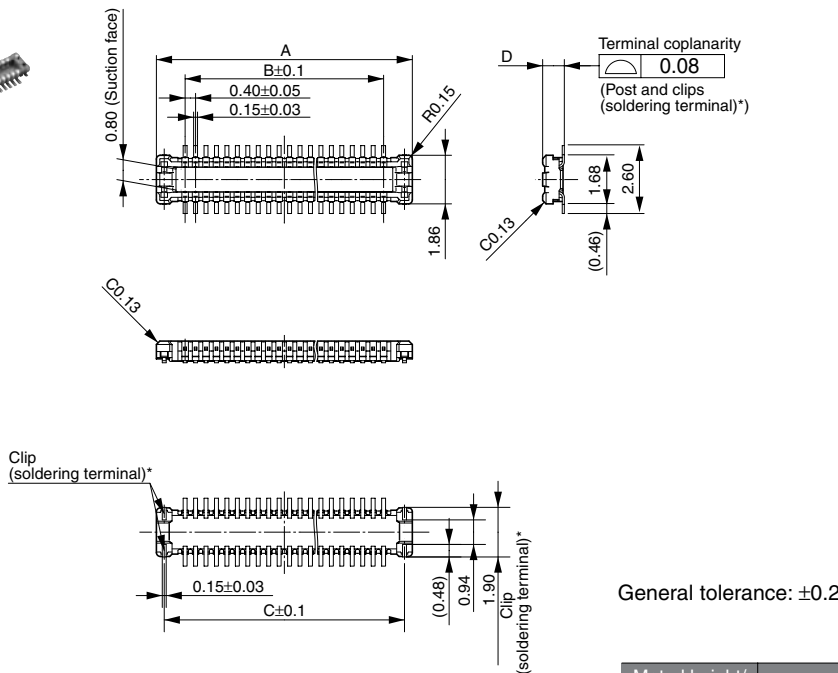

General tolerance: ±0.2

Mated height/ dimension	D
1.0mm	0.83
1.2mm	1.01

Dimension table (mm)

Number of contacts/ dimension	A	B	C
10	3.8	1.6	3.2
12	4.2	2.0	3.6
14	4.6	2.4	4.0
16	5.0	2.8	4.4
18	5.4	3.2	4.8
20	5.8	3.6	5.2
22	6.2	4.0	5.6
24	6.6	4.4	6.0
26	7.0	4.8	6.4
28	7.4	5.2	6.8
30	7.8	5.6	7.2
32	8.2	6.0	7.6
34	8.6	6.4	8.0
36	9.0	6.8	8.4
38	9.4	7.2	8.8
40	9.8	7.6	9.2
42	10.2	8.0	9.6
44	10.6	8.4	10.0
46	11.0	8.8	10.4
48	11.4	9.2	10.8
50	11.8	9.6	11.2
54	12.6	10.4	12.0
60	13.8	11.6	13.2
64	14.6	12.4	14.0
70	15.8	13.6	15.2
80	17.8	15.6	17.2

• Socket and Header are mated

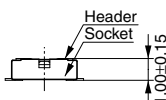

Mated height: 1.0 mm

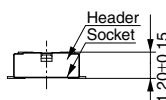

Mated height: 1.2 mm

Kameraanwendungen



Autopilot



Live-Streaming



Videokonferenz



Biometrische Eye-Tracker-Erkennung

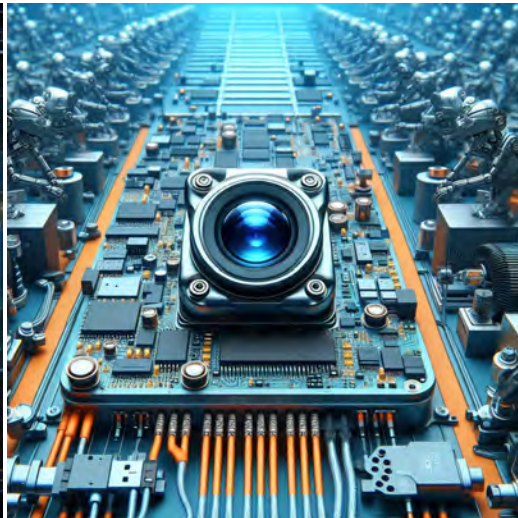

Maschinelles Sehen



Agrarmonitor



Nachtsichtsicherheit



Drohnen- und Sport-Adleraugen



Interaktive Haustierkamera



YDS CAMERA MODULE

your best camera partner

Referenztabelle für die Pinbelegungsdefinition des Kameramoduls

OmniVision Sony Himax Samsung On-Semi Aptina Himax GalaxyCore PixArt Bildsensoren	
Pin Signal	Beschreibung
DGND GND	Masse für digitale Schaltung
AGND	Masse für analoge Schaltung
PCLK DCK	DVP-PCLK-Ausgang
XCLR PWDN XSHUTDOWN STANDBY	Abschalten aktiv hoch mit internem Pulldown-Widerstand
MCLK XVCLK XCLK INCK	Systemeingangsuhr
RESET RST	Aktiv Low mit internem Pull-up-Widerstand zurücksetzen
NC NULL	keine Verbindung
SDA SIO_D SIOD	SCCB-Daten
SCL SIO_C SOIC	SCCB-Eingangstakt
VSYNC XVS FSYNC	DVP-VSYNC-Ausgang
HREF XHS	DVP-HREF-Ausgang
DOVDD	Strom für E/A-Schaltung
AFVDD	Strom für VCM-Schaltung
AVDD	Strom für analoge Schaltung
DVDD	Strom für digitale Schaltung
STROBE FSTROBE	Strobe-Ausgang
FSIN	Synchronisieren Sie das VSYNC-Signal vom anderen Sensor
SID	SCCB letzte Bit-ID-Eingabe
ILPWM	mechanische Shutter-Ausgangsanzeige
FREX	Rahmenbelichtung / mechanischer Verschluss
GPIO	Allzweckeingänge
SLASEL	I2C-Slave-Adresse auswählen
AFEN	CEN-Chip aktivieren aktiv hoch auf VCM-Treiber-IC
MIPI Schnittstelle	
MDN0 DN0 MD0N DATA_N DMO1N	MIPI 1st negative Ausgabe der Datenspur
MDP0 DP0 MD0P DATA_P DMO1P	MIPI 1st positiver Ausgang der Datenspur
MDN1 DN1 MD1N DATA2_N DMO2N	MIPI 2nd negative Ausgabe der Datenspur
MDP1 DP1 MD1P DATA2_P DMO2P	MIPI 2nd positiver Ausgang der Datenspur
MDN2 DN2 MD2N DATA3_N DMO3N	MIPI 3rd negative Ausgabe der Datenspur
MDP2 DP2 MD2P DATA3_P DMO3P	MIPI 3rd positiver Ausgang der Datenspur
MDN3 DN3 MD3N DATA4_N DMO4N	MIPI 4th negative Ausgabe der Datenspur
MDP3 DP3 MD3P DATA4_P DMO4P	MIPI 4th positiver Ausgang der Datenspur
MCN CLKN CLK_N DCKN	MIPI Uhr negativer Ausgang
MCP CLKP MCP CLK_P DCKN	MIPI Takt positiver Ausgang
DVP Parallel Schnittstelle	
D0 DO0 Y0	DVP Datenausgabeport 0
D1 DO1 Y1	DVP Datenausgabeport 1
D2 DO2 Y2	DVP Datenausgabeport 2
D3 DO3 Y3	DVP Datenausgabeport 3
D4 DO4 Y4	DVP Datenausgabeport 4
D5 DO5 Y5	DVP Datenausgabeport 5
D6 DO6 Y6	DVP Datenausgabeport 6
D7 DO7 Y7	DVP Datenausgabeport 7
D8 DO8 Y8	DVP Datenausgabeport 8
D9 DO9 Y9	DVP Datenausgabeport 9
D10 DO10 Y10	DVP Datenausgabeport 10
D11 DO11 Y11	DVP Datenausgabeport 11

www.YDSCAM.com sales@ydscam.com Phone (WeChat, QQ): (+86) 177 2732 6718

All rights reserved @ YingDeShun Co. Ltd. Specifications subject to change without notice.

Kamera-Zuverlässigkeitstest

Zuverlässigkeitsprüfpunkt		Testmethode	Akzeptanzkriterium	
Kategorie	Artikel			
Umwelt	Lager Temperatur	Hoch 60°C 96 Std	Temperaturkammer	Keine anormale Situation
		Niedrig -20°C 96 Std	Temperaturkammer	Keine anormale Situation
	Betriebs Temperatur	Hoch 60°C 24 Std	Temperaturkammer	Keine anormale Situation
		Niedrig -20°C 24 Std	Temperaturkammer	Keine anormale Situation
	Feuchtigkeit	60°C 80% 24 Std	Temperaturkammer	Keine anormale Situation
	Thermischer Schock	Hoch 60°C 0.5 Std Niedrig -20°C 0.5 Std Radfahren rein 24 Std	Temperaturkammer	Keine anormale Situation
Physisch	Falltest (Im freien Fall)	Ohne Verpackung 60cm	10 Mal auf Holzboden	Elektrisch funktionsfähig
		Mit Paket 60cm	10 Mal auf Holzboden	Elektrisch funktionsfähig
	Vibrations Test	50Hz X-Axis 2mm 30 Minuten	Vibrationstisch	Elektrisch funktionsfähig
		50Hz Y-Axis 2mm 30 Minuten	Vibrationstisch	Elektrisch funktionsfähig
		50Hz Z-Axis 2mm 30 Minuten	Vibrationstisch	Elektrisch funktionsfähig
	Zugfestigkeit des Kabels Krafttest	Gewicht laden 4 kg 60 Sekunden Radfahren rein 24 Std	Zugprüfmaschine	Elektrisch funktionsfähig
Elektrisch	ESD-Test	Kontaktaufnahme 2 KV	ESD-Prüfmaschine	Elektrisch funktionsfähig
		Luftentladung 4 KV	ESD-Prüfmaschine	Elektrisch funktionsfähig
	Alterungstest	On/Off 30 Sekunden Radfahren rein 24 Std	Stromschalter	Elektrisch funktionsfähig
	USB-Anschluss	On/Off 250 Mal	Einstecken und ausstecken	Elektrisch funktionsfähig



Kamerainspektionsstandard

Inspektionsgegenstand		Untersuchungsmethode	Inspektionsstandard	
Kategorie	Artikel			
Aussehen	FPC oder PCB	Farbe	Das bloße Auge	Größere Unterschiede sind nicht zulässig.
		Zerrissen/gehackt werden	Das bloße Auge	Das Freilegen von Kupferrissen ist nicht zulässig.
		Markierung	Das bloße Auge	Klar, erkennbar (innerhalb von 30 cm Entfernung)
	Halterin	Kratzer	Das bloße Auge	Die Freilegung von Rissen im Inneren ist nicht zulässig
		Lücke	Das bloße Auge	Erfüllen Sie den Höhenstandard
		Schraube	Das bloße Auge	Stellen Sie sicher, dass Schrauben vorhanden sind (falls vorhanden)
		Schaden	Das bloße Auge	Die Freilegung von Rissen im Inneren ist nicht zulässig
	Linse	Kratzen	Das bloße Auge	Keine Auswirkung auf den Auflösungsstandard
		Kontamination	Das bloße Auge	Keine Auswirkung auf den Auflösungsstandard
		Ölfilm	Das bloße Auge	Keine Auswirkung auf den Auflösungsstandard
		Abdeckband	Das bloße Auge	Kein Problem beim Aussehen.
	Funktion	Bild	Keine Kommunikation	Testboard
Helles Pixel			Tafel	Im Image Center nicht erlaubt
Dunkles Pixel			Weißer Tafel	Im Image Center nicht erlaubt
Verschwommen			Das bloße Auge	Nicht erlaubt
Kein Bild			Das bloße Auge	Nicht erlaubt
Vertikale Linie			Das bloße Auge	Nicht erlaubt
Horizontale Linie			Das bloße Auge	Nicht erlaubt
Kleines Leck			Das bloße Auge	Nicht erlaubt
Blinkendes Bild			Das bloße Auge	Nicht erlaubt
Prellung			Inspektionslehre	Nicht erlaubt
Auflösung			Diagramm	Folgt dem Diagrammstandard für ausgehende Inspektionen
Farbe			Das bloße Auge	Kein Problem
Lärm			Das bloße Auge	Nicht erlaubt
Ecke dunkel			Das bloße Auge	Weniger als 100 x 100 Pixel
Farbauflösung			Das bloße Auge	Kein Problem
Abmessungen	Höhe	Das bloße Auge	Befolgt Zulassungsdatenblatt	
	Breite	Das bloße Auge	Befolgt Zulassungsdatenblatt	
	Länge	Das bloße Auge	Befolgt Zulassungsdatenblatt	
	Gesamt	Das bloße Auge	Befolgt Zulassungsdatenblatt	

YDSCAM Paketlösungen

YDSCAM Kameramodul



Komplett mit Linsenschutzfolie

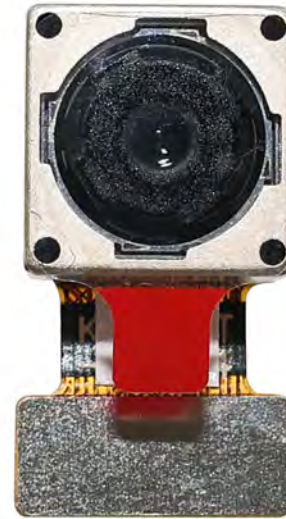

Tablett mit Gitter und Raum



Legen Sie die Kameras auf das Tablett

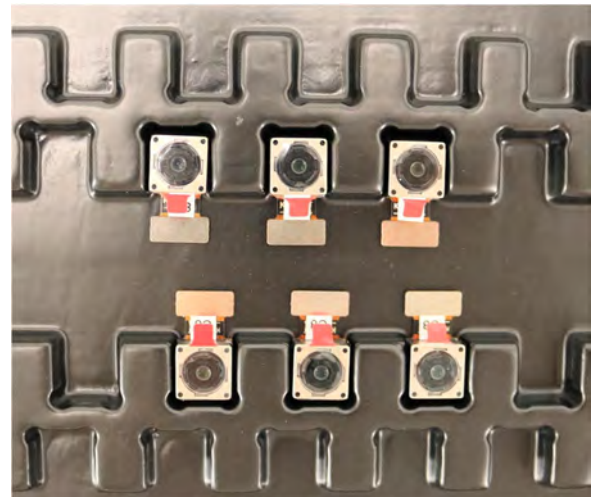

YDSCAM Paketlösungen

Volles Fach mit Kameras



Decken Sie das Tablett mit dem Deckel ab

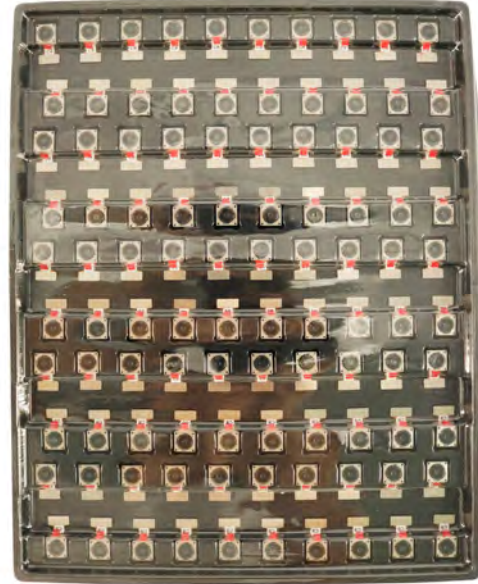

Legen Sie das Tablett in den antistatischen Beutel



Staubsaugen Sie den antistatischen Beutel



YDSCAM Paketlösungen

Versiegelter antistatischer Vakuumbbeutel mit Etiketten

1. Modell und Beschreibung 2. Menge 3. Herstellungsdatumscode 4. Achtung



YDSCAM Paketlösungen

Legen Sie Schaumstoffplatten zwischen die Tablettbeutel



Schaumstoffplatten sind größer als Tablettbeutels



Legen Sie Schaumstoffplatten und Tablettbeutels in den Karton



Die Schaumstoffplatten sitzen fest im Karton



Verschließen Sie die Carbon Box



Beschriften Sie den Carbon-Versandkarton



YDSCAM Paketlösungen

USB-Kameramodul

Komplett mit Objektivschutzfolie

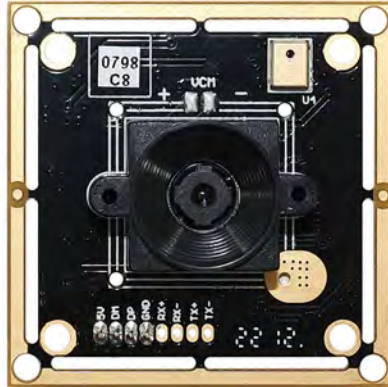

Legen Sie die Kameraprobe in den antistatischen Beutel

Legen Sie USB-Kameras in das Fach



Verschließen Sie das Tablett mit einem antistatischen Beutel

Beschriften Sie den Carbon-Versandkarton



YDSCAM Paketlösungen

Legen Sie die Kameraprobe in den antistatischen Beutel



Legen Sie die Steckverbinder in den antistatischen Beutel



Beschriften Sie die Probenbeutel



Stecken Sie die Steckverbinder in die Spule



Legen Sie Proben in die Carbonbox



Stecken Sie die Steckverbinder in die Carbonbox





Firma YDSCAM

YingDeShun Co. Ltd. (YDS) wurde 2017 gegründet, ein technologieorientierter Hersteller der nächsten Generation, der sich auf Forschung, Design und Produktion von Audio- und Videoprodukten spezialisiert hat. YDS verfügt über 20.000 Quadratmeter große automatisierte Anlagen mit 100 Mitarbeitern und einem Jahresdurchsatz von 30.000.000 Kameraeinheiten.

YDS bietet OEM- und ODM-Design sowie Auftragsfertigung und baut die Kameraprodukte. Sie können uns die Anforderungen mitteilen, sogar mit einem Handentwurf. Unser Vertrieb und unsere Technik arbeiten zusammen, um Ihre Anforderungen zu erfüllen. Wir verstehen uns als Ihr langfristiger Partner bei der Entwicklung praktischer und innovativer Lösungen.

Unser Team deckt alles von der ersten Konzeptentwicklung bis zum Massenprodukt ab. YDS ist auf kundenspezifisches Kameradesign, Rohmaterial, Elektroniktechnik, Firmware-/Softwareentwicklung, Produkttests und Verpackungsdesign spezialisiert. Unsere erfahrenen strategischen Liefersysteme bieten eine robuste und zuverlässige Fertigungskapazität für Aufträge unterschiedlicher Größe.

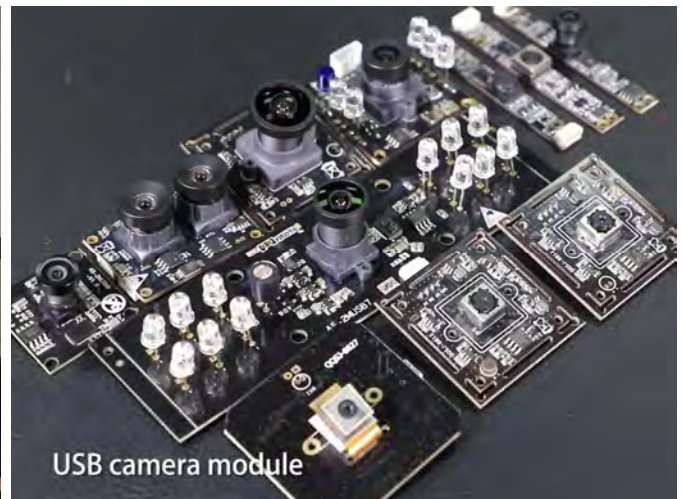

Eingeschränkte Garantie

YDS gewährt die folgende eingeschränkte Garantie, wenn Sie das/die Produkt(e) direkt von der YDS-Firma oder über die YDS-Website www.YDSCAM.com erworben haben. Von anderen Verkäufern oder Quellen gekaufte Produkte fallen nicht unter diese eingeschränkte Garantie. YDS garantiert, dass die Produkte bei normalem Gebrauch für einen Zeitraum von einem (1) Jahr ab dem Datum, an dem Sie das Produkt erhalten („Garanzzeitraum“), frei von Material- und Verarbeitungsfehlern sind.

Für alle Produkte, die während der Garanzzeit wesentliche Material- oder Verarbeitungsfehler aufweisen oder entwickeln, wird YDS nach eigenem Ermessen entweder: (i) das/die Produkt(e) reparieren; (ii) das/die Produkt(e) durch ein/e neue oder generalüberholte(n) Produkt(e) ersetzen (wobei das/die Ersatzprodukt(e) vom identischen Modell oder einer gleichwertigen Funktion sein müssen); oder (iii) Ihnen eine Rückerstattung des Preises gewähren, den Sie für das/die Produkt(e) bezahlt haben.

Diese eingeschränkte Garantie von YDS beschränkt sich ausschließlich auf Reparatur und/oder Ersatz gemäß den oben dargelegten Bedingungen. YDS ist nicht zuverlässig oder verantwortlich für etwaige Folgeereignisse.





YDS CAMERA MODULE

your best camera partner

Unsere Unternehmensstärke

Leistungsstarke Fabrik



Professioneller Service



Versprochene Lieferung



www.YDSCAM.com sales@ydscam.com Phone (WeChat, QQ): (+86) 177 2732 6718

All rights reserved @ YingDeShun Co. Ltd. Specifications subject to change without notice.